

FAUSTINA[®]

USER MANUAL

Model: 3SR



**HOME-USE IPL
BEAUTY DEVICE**

3x SKIN REJUVENATION

LAB  TEST



Welcome to your new

FAUSTINA®

3SR 1,500,000 Shots IPL

The box contains **3 lamps**
1 lamp attached to the device
2 lamps on the side

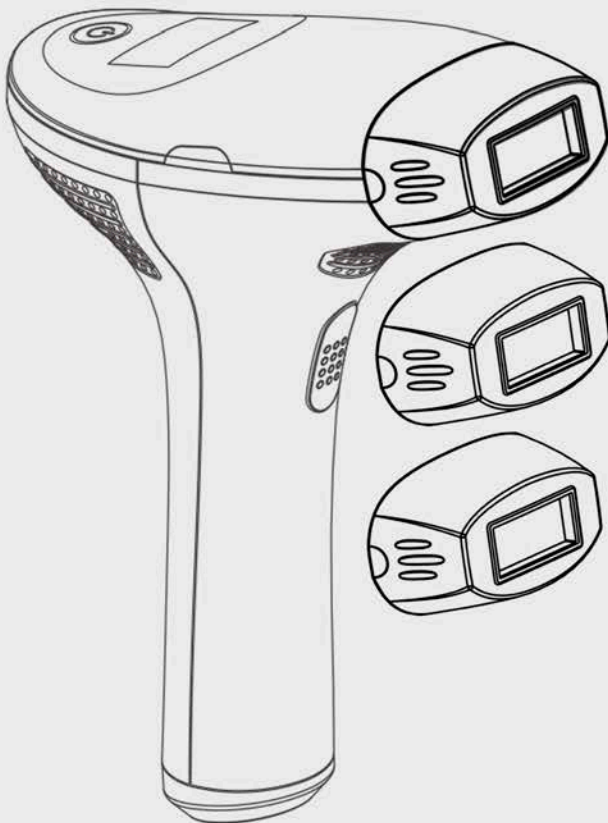

1x Skin Rejuvenation

1x Skin Rejuvenation

1x Skin Rejuvenation

Table of Contents

Preface	1 - 2
Product Notice	3 - 4
Product Information	4 - 6
Warnings	7 - 8
Cautions	9 - 10
How to use FAUSTINA IPL	11 - 13
Skin Sensitivity Test	13 - 14
Energy Settings	13 - 14
Operation Procedure	15 - 20
FAQs before using the device	21 - 30
FAQs after using the device	31 - 36
Replacing the UK adapter	37
Warranty	37 - 39
Service Information	40 - 42

Preface

Thank you for choosing the FAUSTINA (Multi-functional) IPL beauty device from LaboTest. This device uses E-IPL technology (filters out harmful and invalid lights to maintain effective shots for all functions), and you can achieve hair removal, skin rejuvenation and acne clearance by switching to the appropriate function lamp.

Hair Removal and Acne Treatment Lamps can be purchased individually and installed on the device.

This product was built with efficiency, fashion, health and high-tech specifications in mind. Get ready as FAUSTINA IPL marks the beginning of your very own private beauty clinic.

Please view and read this user manual very carefully before using the device, and keep this manual safe in case you need to refer to it in the future.

If you have any problems with your device, feel free to contact us on our website at www.labotest.co.uk/contact.

Product Notice

- This user manual will guide you through the usage of your FAUSTINA IPL device.
- The manufacturer of this product follows sustainable development strategies. This means they retain the right not to notify customers when they change product function, interface and appearance.
- If there is a difference between the description and the actual product due to an upgrade, please refer to the actual product.
- Please use the device according to the correct operational steps and treatment settings.

Product Information

Contains:

Main unit x1, Lamp x3, UV glasses x1, Adapter x1,
User manual x1

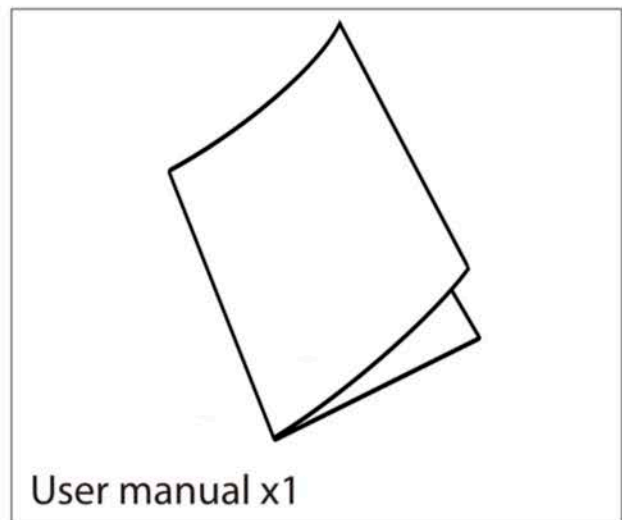
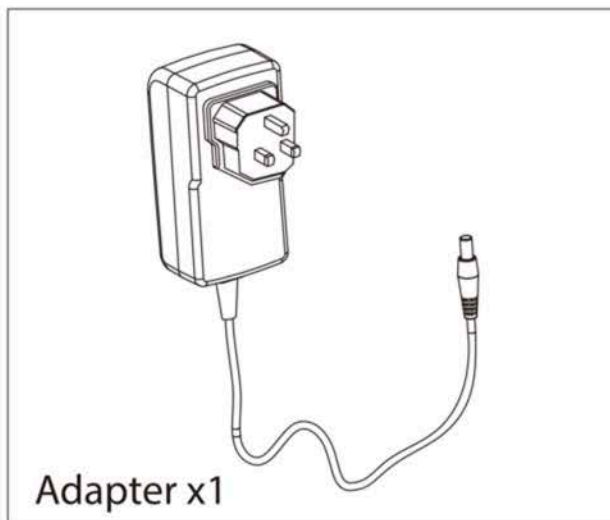
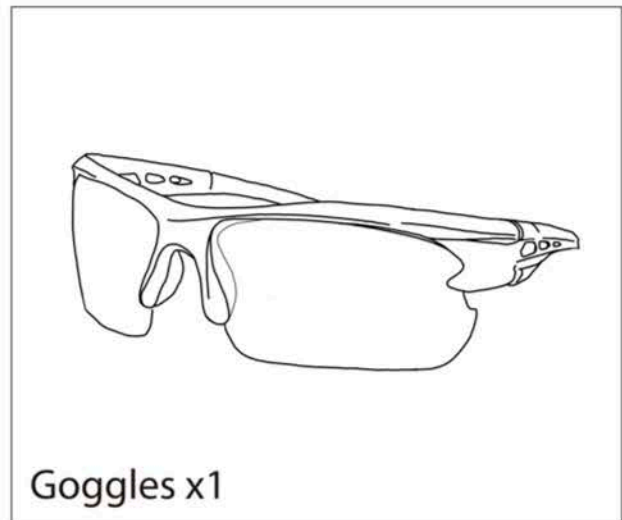

Model number: 3SR

Function: Skin Rejuvenation lamps that need to be changed when 0 flashes have been reached.

Functions

Function 1 - Skin Rejuvenation

Figure 1: Lamps

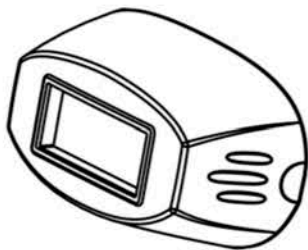

SR (Skin Rejuvenation)

Parameters

Input Power: 36W

Voltage Rating: 100V - 240V

Rated Frequency Range: 50Hz/60Hz

Storage Temperature: 0°C - 45°C

Working Temperature: 5°C - 35°C

Working Humidity: 25% - 75%

Product Structure: (Figure 2)

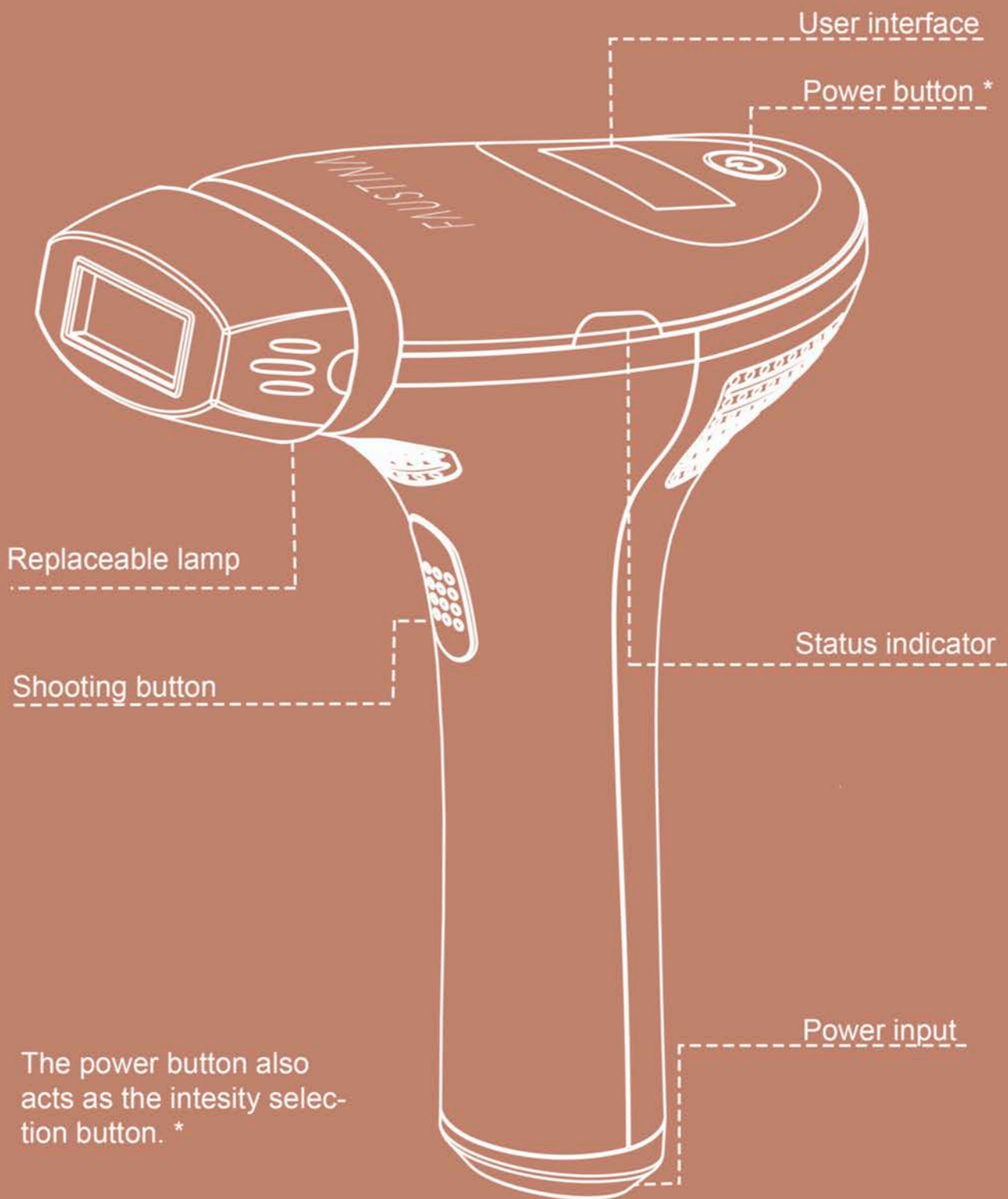

Warnings

Please read through these carefully.

DO NOT USE if you are under the age of 18. The effects of using the system in this age group are unknown.

+18

DO NOT USE if the skin in the area you wish to treat is tanned or burned. Using the device on tanned or burned skin may result in temporary (or even permanent) whitening or darkening of your skin.



DO NOT USE if you are pregnant, conceiving or breast-feeding. Hormonal changes occur during pregnancy and breast-feeding, and could increase the risk of skin injury or sensitivity.



DO NOT USE if you have epilepsy, light-induced seizures or migraines. The energy flashes might cause severe headaches and migraines.



DO NOT USE on tattoos, dark brown or black spots (such as dark freckles, birthmarks, moles or warts). Tattoos or dark spots may absorb too much light energy which could cause your skin to swell, leave temporary or permanent blisters or discolour your skin. It may also cause burns.



DO NOT USE HR lamp on your head, ears, neck, nipples, genitalia or around the anus. **DO NOT USE SR lamp** on your head, nipples, genitalia or eyebrows. Use in these areas could cause skin swelling, blisters, or temporary skin discoloration. **We do not recommend the use of the SR lamp on the neck area, as it is very sensitive.**

DO NOT USE if you have any active skin conditions in the area you are going to treat. This includes acne (when using HR or SR lamp), sores, psoriasis, eczema, burns, herpes simples, wounds, or rashes. These conditions can make your skin more sensitive to the light treatment, and could make treatments uncomfortable or cause skin swelling, blisters, or infections. If you feel any pre-existing skin conditions have healed enough to use the device, please consult your doctor or dermatologist first.

DO NOT USE the device if you have a history of **keloidal scar formation**, a known **sensitivity to light** (photosensitivity) or are taking medication that makes your skin more sensitive to light, including non-steroidal anti-inflammatory reagents e.g. **Aspirins, Ibuprofens, Centaminophens, Tetracyclines, Phenothiazines, Thiazide, Diuretics, Sulfonylureas, Hydroxy Acids (AHAS), Beta-Hydroxy Acids (BHAS), Retin-A, Accutane and/or Typical retinoids.**

DO NOT USE if you have a disease related to photosensitivity, such as **porphyria, polymorphic light eruption, solar urticaria, lupus, etc.** These conditions makes your skin more sensitive to light treatment and could make the treatment uncomfortable or cause skin swelling, blisters, or infections.

DO NOT consume the following medicines if you are going to proceed with an IPL treatment: **Accutane, Roaccutan, Retin A, Vitamin B, or AHA within the past 6 months.**

Cautions

Please read through these carefully.

You cannot power on the device if no lamp is connected to it. Disconnect the device from the adapter first to replace the lamp. During this operation, do not cover the ventilation holes to prevent overheating.

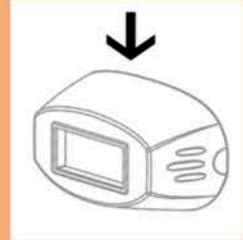

When using the Hair Removal Lamp always make sure to shave the area you are going to treat.

We recommend you wear the UV protection glasses provided in your package while undergoing treatment. Do not look directly at the light or flashes for long periods of time.

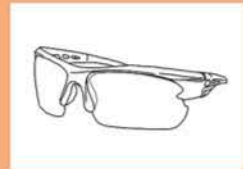

Scrapped lamps cannot be recycled. Please deal with scrapped lamps according to your local laws and ordinances.



Before undergoing the treatment, clean your skin and make sure it's dry. Do not apply cosmetics as certain chemicals could cause the device to malfunction or not work as intended.



Adjust the energy level from low to high. On condition of safety, the higher the energy level, the better your results will be. After your treatment, it is normal to experience redness. In those cases, it is recommended you apply an ice pack to the affected areas.

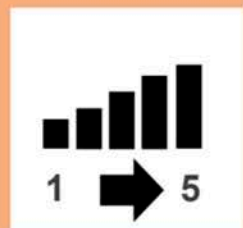

Use a skin moisturiser and sun protection product after photo-therapy treatment.

Once treatment is complete and you have powered off your device, please use a wet cotton swab or cloth to clean the treatment window. This can prevent hair from hardening onto the surface of the lamp, subsequently affecting the energy of every shot.

Only use a soft, dry cloth, or microfibre cloth to clean the outside of the device. You can also use an alcohol-free wipe or wet cloth.



Please make sure your unit's system, accessories and lamp(s) do not get in contact with any water or humidity.

Please store the device and its accessories in a dry and ventilated environment, and keep away from children.

Do NOT poke metal instruments or any other kind of objects into the heat emission holes. This poses a risk of electric shock.



In case your device becomes submerged or otherwise soaked in water, please send it back to the manufacturer for examination to determine whether it is repairable. In case the system is on when soaked, please immediately UNPLUG your system first before touching the device for your health and safety.

Do NOT try to disassemble and repair at your own discretion.

If your device fails to operate normally, please return the unit and accessories back to the manufacturer, where qualified maintenance personnel will examine it for you.



How to use FAUSTINA IPL

It's so simple — you'll love it.

- 1** Clean the cartridge light output window with a damp cloth or cotton swab. This is done in order to remove any hair and dust from the treatment window.

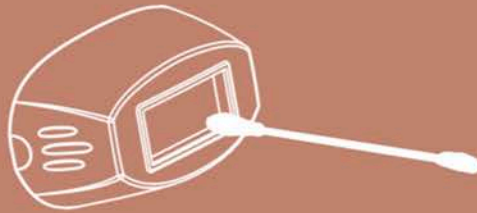

- 2** Please hold the lamp on both sides, as depicted below, then insert or pull out in a straight motion.



- 3** Connect the power cord to the device.



- 4** Place your system onto a table or area near an electrical outlet. Move any liquids away from the area.

- 5** Make sure the lamp is installed correctly before turning it on.

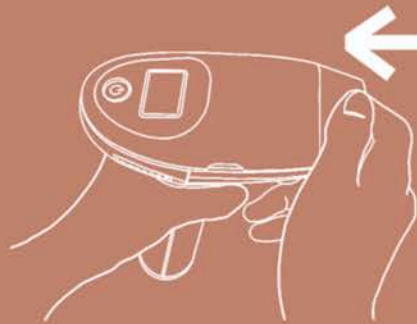

-
- 6** After connecting the power cord to an electrical outlet, status indicators will start to flash slowly.



-
- 7** Press the power button for over 2 seconds to power on the device. After turning it on, you will hear the fans and see the LCD display turn on. The lamp type, remaining shots, energy level, thermometer icon and the fan icon will be shown and indicated on the LCD display. The status indicators will continue to flash, meaning the device is getting ready for use. Once it's ready, the indicators will go out. When the treatment window comes into skin contact, the indicators will turn blue which means the device is ready to emit flashes.

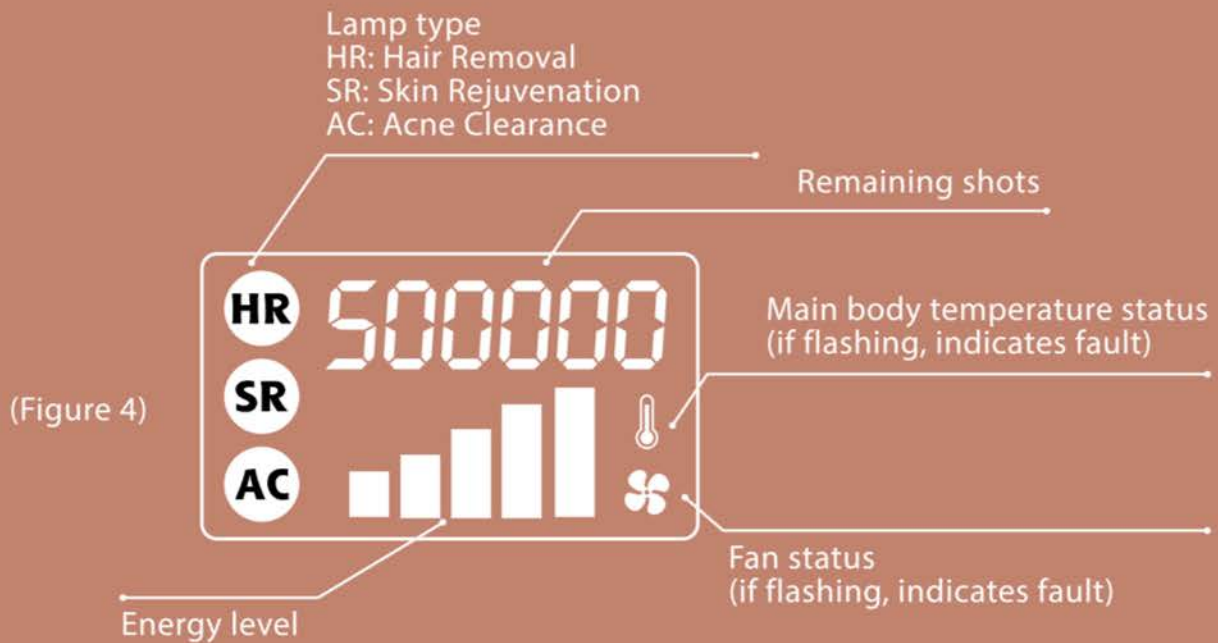

- Press the power button to adjust the energy level from low to high: Level 1 is the lowest, and Level 5 is the highest.
- Make sure the treatment window is placed firmly against your skin. The status indicators will light up when the treatment window is facing a suitable



Note: The device will power off automatically after 5 minutes of no activity.

Skin Sensitivity Test

In case you are using IPL for the first time

If you're using this system for the first time or on a new area on your body, choose a small area close to the area you intend to treat, for the purpose of performing a skin sensitivity test. Use the lowest level (1). Follow the treatment instructions below, but make sure to emit only 2-3 shots. After the skin test, wait for about 60 minutes, and check your skin for any reactions. If after 60 minutes the skin appears normal and there is no redness or other skin reaction, then you are ready to perform a full treatment.

Energy Settings

Calibration made easier with an LCD display

Choose the suitable energy level according to your skin tolerance, and gradually increase the energy level from one to five. If there isn't any intolerable pain or reaction of any kind, you can feel free to gradually increase the energy. Do not use the device on the exact same part of your skin by flashing multiple times. Doing so may cause too much heat, and may result in skin swelling, blisters, or temporary/permanent changes in the colour of your skin. After each flash, slowly move the treatment window to a neighbouring skin spot. Before returning to a previously treated skin spot, wait for at least 20 seconds.

Operation Procedure

The purpose of each lamp

FAUSTINA IPL - Skin Rejuvenation Lamp

(Install SR lamp)

1. Purpose of lamp

For rough and aging skin, dim skin, big pores, wrinkles, lack of elasticity, radiance and facial broken capillaries

2. Operation procedure

- 1** Clean the area you are going to treat, and the lamp's filter with a cotton bud.
- 2** Wear UV protection glasses to avoid getting dazzled.
- 3** Choose a suitable energy level
(Refer to pages 13 - 14 - Start from a low level)
- 4** Place the treatment window firmly against your skin, and treat different areas as you go.
Do not shot the exact same spot repeatedly.
- 5** Start the treatment. Repeat step 4 for 2-3 times.

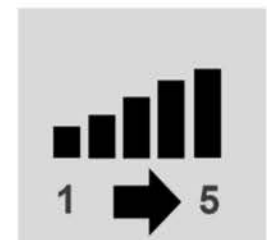
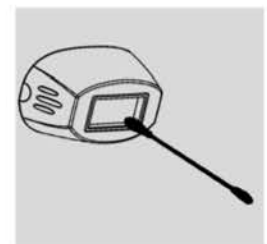
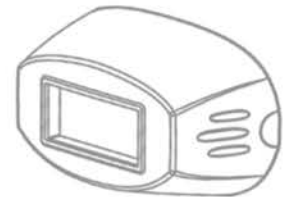

6 Apply moisturiser after treatment (optional/recommended).



7 Power off the device, and use a damp cloth or cotton swab to clean the treatment window.



8 Put the device and its accessories back into their box and store it in a cool, dry, safe place. Keep away from children and liquids.

3. Treatment Recommendations

8 treatments - One treatment every week

(This Lamp can be purchased individually and installed on the device.)

FAUSTINA IPL - Hair Removal Lamp

(Install HR lamp.)

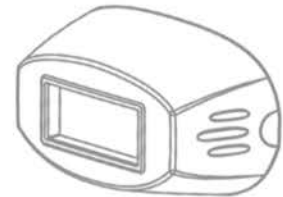

1. Purpose of lamp

For the removal of lip hair, armpit hair, body hair and legs, hair in places that are affecting your appearance (such as on your forehead and bikini area, for example).

The effect is different according to skin colour. This device is not suitable for red (ginger), grey/white and white-blond hair.

Skin and hair guides



2 . Operation procedure

1 Shave and clean the area you are going to treat.

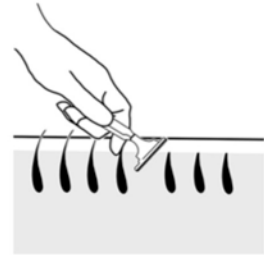

2 Wear UV protection glasses to avoid getting dazzled.

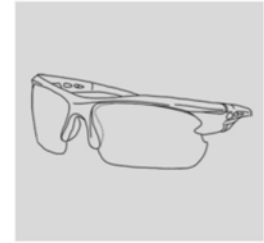

3 Choose a suitable energy level
(Refer to pages 13 - 14 - Start from a low level)



4 Place your system onto a table or area near an electrical outlet. Move any liquids away from the area.

5 Start the treatment. Repeat step 4 for 2-3 times.



PRO-TIP: To treat larger areas, you can use Glide Mode. To activate this mode, simply place the treatment window against your skin, press the shooting button once (but do not release the button), and slowly slide the treatment window across your skin. It will flash automatically as you go along. This is particularly useful for midribs, legs and thighs.

6 Apply anti-hair cream after treatment (optional).

7 Power off the device, and use a damp cloth or cotton swab to clean the treatment window.

8 Put the device and its accessories back into their box and store it in a cool, dry, safe place. Keep away from children and liquids.



3. Treatment Recommendations

7-9 treatments

In the first 3 treatments, do one treatment every week.

In the following 4-9 treatments, do one treatment every 2-3 weeks.

During the maintenance period, do one treatment every 2 months on areas with visible hair growth.

(This Lamp can be purchased individually and installed on the device.)

FAUSTINA IPL - Acne Clearance Lamp

(Install AC lamp)

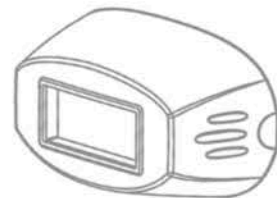

1. Purpose of lamp

For oily skin with papula, impetigo, tuber and cystic inflammatory acne.

2. Operation procedure

- 1** Clean the area you are going to treat, and the lamp's filter with a cotton bud.
- 2** If there is any inflammatory acne before treatment, clean the affected areas with appropriate products.
- 3** Wear UV protection glasses to avoid getting dazzled.
- 4** Choose a suitable energy level
(Refer to pages 13 - 14 - Start from a low level)
- 5** Place the treatment window firmly against your skin.
Make sure each shot interval is at least 20 seconds.

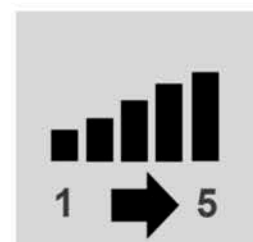
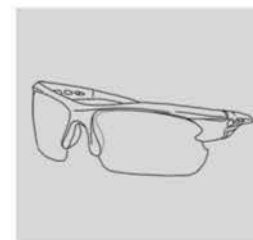
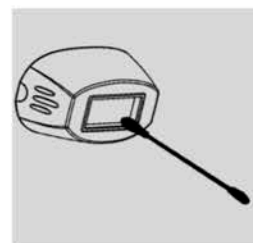

6 Power off the device once done. Keep skin clean and apply moisturiser after treatment.



7 Use a damp cloth or cotton swab to clean the treatment window.



8 Put the device and its accessories back into their box and store it in a cool, dry, safe place. Keep away from children and liquids.

3. Treatment Recommendations

10 treatments - Every 3 days

FAQs

Frequently asked questions before using the FAUSTINA IPL

I have never used IPL hair treatments. Is it really safe?

Key points for our IPLs safety:

1- Shaving beforehand will prevent your skin from getting burned or irritated in the process. The light from your device will be able to target the melanin in your hair much more easily this way, as it acts similarly to a conductor.

2- For facial treatment, you will need to make sure your face is clean and free from any water, creams, and oils prior to using IPL.

3- Use it on the correct skin/hair type, choose a suitable energy level according to your skin tolerance, and gradually increase the energy level from one to five. If there isn't any intolerable pain or reaction of any kind, you can feel free to gradually increase the energy.

4- Do not use the device on the exact same part of your skin by flashing multiple times. Doing so may cause too much heat, and may result in skin swelling.

5- Home IPL machines are for use on healthy normal skin. Do not use the IPL hair removal on moles. Do not use the IPL hair removal if you have diabetes or if you are undergoing chemotherapy or consumed Photo-Sensitive Drugs or you are epileptic. It is important to inform your GP or a specialist beforehand if you are on certain medications before using an IPL.

So the IPL is completely safe, right?

Yes, our IPLs' home system are perfectly safe as long as you use them in the prescribed manner and on the right type of skin and hair.

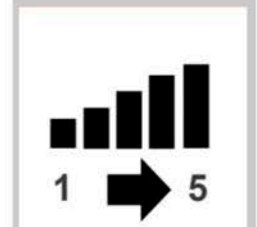

Who can use an IPL - Is it just for women?

It's for anyone who has unwanted hair. For women and men who want to look younger with healthier-looking skin. For whoever wants to eliminate flushing, age spots, chronic redness, or wrinkles. IPL can work for you!



Are FAUSTINA IPL hair removal results permanent? Does this mean my hair will never grow back again?

When the hairs grows back, it will be lighter, finer, and fewer in number. After four to six treatments, you can expect a marked reduction in hair. Any regrowth can be managed with touch-up treatments every six to 12 months.

Can I use an IPL during pregnancy?

Treatment cannot be done during pregnancy and lactation. This is due to the hormonal and pigmentation changes occurring during pregnancy. It is recommended to undergo the treatment after lactation and after completing 2 cycles of menstruation.



Can I use the IPL device during menstruation?

During menstruation, pubic area treatment cannot be done.

Can I use the IPL if I have a certain condition?

You cannot use IPL if you have consumed, applied or have had the following:

- Accutane, Roaccutane, Retin A, Vitamin B or AHA within the past 6 months
- Have sunburned, windburned, dry, chapped, irritated or broken skin or any open wounds on the treatment area
- Have sores, warts, ulcers, moles, birthmarks or any tattoo in the treatment area

Had Radiation treatment (e.g.: UV Sun tanning), electrolysis or excess sunbathing within the past 6 months

- Had excess sunbathing within the past week
- Had a surgical procedure in the past months
- Are pregnant or breastfeeding

Note: Avoid swimming in strong chlorinated water immediately before an IPL treatment session.

Avoid exfoliating, microdermabrasion, or peels for 1 week before treatment sessions.

In what cases am I advised not to undergo IPL treatments?

If you have diabetes – People with diabetes should understand that their condition compromises their immune system. Therefore, the healing process of possible adverse effects will take longer than usual. Risks of infection are also of utmost concern.

If you're undergoing chemotherapy – Patients who are currently undergoing chemotherapy also possess a compromised immune system which makes them not ideal for IPL treatments.

If you've consumed Photo-Sensitive Drugs – There are a handful of photo-sensitive drugs that may potentially intensify one's sensitivity or response to IPL treatments.

If you are epileptic – Light from the treatment can trigger a fit.

It is important to inform your GP or a specialist beforehand if you are on certain medications before using IPL.

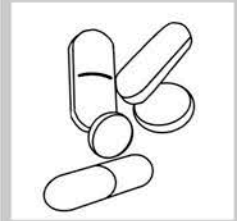

What is the recommended minimum age?

There is no minimum or maximum age for IPL treatment. However, children under the age of 18 should not use IPL devices or undergo treatments. This is because hormone balances in the body are unstable and new hair growth is rapid.

+18

Can I use IPL devices for a bikini depilation?

It is safe and gentle to use IPL around your bikini area to get rid of unwanted hair. Whether you prefer a Brazilian (just a strip of hair) or a full-on Hollywood look; maybe just tidy up the edges. With IPL, you can permanently enjoy smooth skin and forget all about expensive salon treatments.



Will the flashing light hurt my eyes?

The safety system in our products has been developed in the device, rendering flashing light harmless to your eyes. Use the device in a well-lit room so that the light is less glaring to your eyes. It is not needed to wear goggles during use. Never use IPL in the area around your eyes or for treating your eyebrows. This is the only thing you should remember.

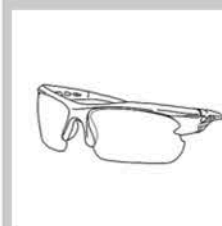

How to prepare the skin before an IPL treatment?

You should pre-treat your skin by removing hair off of the surface of your skin the same day of treatment or the day before.

For best results, we recommend that you don't do any form of waxing, plucking, bleaching, and electrolysis treatments. Shaving is your new favorite hair removal method before and between the treatments; anything else pulls hair from the follicle and hinders the IPL process, which you don't want. If hair grows back between treatments, simply shorten the treatment interval, but do not treat more often than once a week, as this will only increase the risk of skin irritation.

What is the difference between stamp mode and glide mode?

The device has two application modes: Stamp mode and Glide mode. Stamp mode is for small and bony areas that are more difficult to treat (e.g. knees, armpits). Place the appliance on the skin, just press and flash, then move your hand to the next close area which should be treated.



Glide mode is to treat larger areas (e.g. legs). Place the appliance against your skin, while holding the flash button pressed throughout the application – just slide the appliance and it will flash as you go. This makes the treatment of large areas easier and faster.



Is IPL suitable for all skin and hair types?

IPL is usually not suitable for darker skin tones, because there is much more melanin in the skin that the light will target and heat up. This causes pain and can damage your skin. This device has built-in touch and skin tone tester & adjustable flash-strength, adaptable to your skin type.

The darker your hair colour, the better, because dark hair has lots of dark melanin pigment. It's this that the light targets and heats it up to damage the follicle to stop hair growth. Since blonde, grey and white hairs do not contain any or enough melanin, IPL treatments will never work on these hair colours. Red hair contains a different type of melanin which is not responsive to IPL.

Should I remove facial hair before using the IPL?

As with the body, it is important when using IPL that the light energy is channelled into the hair follicles on your body in the most efficient way. This can be done by shaving.

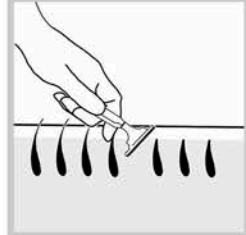

Can FAUSTINA IPL be used if you have metal plates?

FAUSTINA IPL reaches to the deep dermis and the superficial subcutaneous fat layer. It won't penetrate deep enough to affect or cause pain or problems with any metal in your body (e.g. metal screws are usually deeper than that, at the bony structures under the muscle.) It is safe to use FAUSTINA IPL done in your legs, arms, or even metal plates in the chest.

Will FAUSTINA IPL work on light hair and light skin tones?

Yes, you can use it for light skin tones, but unfortunately, IPL does not work for all hair colours and skin tones.

It's important to note that if you have red/ginger, grey/white, or white-blond hair, IPL will not work for you.

Hair removal IPL works by targeting the melanin inside the root of your hair, which all 3 of these hair colours lack — effectively rendering the technology useless.

But despair not!

You can still use FAUSTINA IPL for other purposes, such as skin rejuvenation, rough, ageing skin, dim skin, big pores, wrinkles, lack of elasticity, radiance, broken capillaries and acne reduction! FAUSTINA IPL has proven itself to be very effective in these domains.

What results can I expect?

If your treatments are consistent, you will achieve long-lasting, smooth and hair-free skin. Just bear in mind that it will take multiple treatments in order for you to start seeing results – it takes time. This is because our hair follicles are on their own individual growth cycles. But we promise you will see the remarkable results which bring a smile to your face.



Is FAUSTINA IPL safe to use for rejuvenating skin on medium dark skin?

The best way is to choose a small area close to the area you intend to treat, for the purpose of performing a skin sensitivity test.

Use the lowest FAUSTINA IPL level (1). Follow the treatment instructions below, but make sure to emit only 2-3 shots. After the skin test, wait for about 60 minutes and check your skin for any reactions.

If after 60 minutes the skin appears normal and there is no redness or other skin reaction, then you are ready to perform a full treatment and gradually increase the energy level from (1) to (2).

If there isn't any intolerable pain or reaction of any kind, you can feel free to gradually increase the energy.

How many joules is FAUSTINA IPL and can it get rid of facial broken capillaries?

Light energy is applied to the skin where it is readily absorbed by blood vessels, heating them to a point where they are destroyed. Some small capillaries and veins disappear suddenly. However, 1-7 treatments are needed, one treatment every week. Some capillaries and veins are more visible after the treatment which is a sign that they are destroyed and they will disappear within a few weeks. Results vary depending on the type of skin, capillaries' severity, environmental factors and genetic.

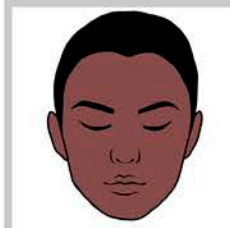

I have medium to dark skin tone is it safe for me to use FAUSTINA IPL?

Unfortunately, it may not work for people with very dark brown to black skin. But, for people with light to brown-dark skin, it's safe and effective.

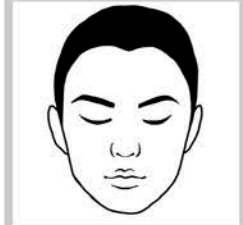

Can FAUSTINA IPL be used on face as well?

FAUSTINA IPL is safe for use on the face. It works effectively on the upper lip. It shouldn't be used near the eyes. For men, we don't advise to use on the beards. Use on male beards may lead to uneven results.

With FAUSTINA IPL you can use Skin rejuvenation and Acne Clearance lamps for reverse sun damage, treat vascular lesions, wrinkle reduction, improve facial contour, tighten pores, boost collagen and elastin production, tighten skin, reduce the appearance of sunspots, freckles, reduce the severity of acne, inflamed skin, and sebum excretion.

Can the IPL tighten the skin on my neck?

We do not recommend the use the Skin Rejuvenation lamp on the neck area, as it is very sensitive.

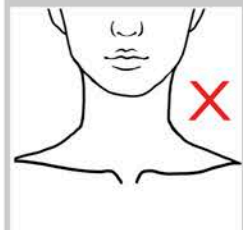

What is the difference or wavelength of the hair removal vs skin rejuvenation and acne clearance FAUSTINA IPL lamp?

The wavelength for FAUSTINA IPL lamps as follows:
Hair Removal: 530 ~ 1100nm, Skin rejuvenation: 560 ~ 1100nm, Acne treatment: 400 ~ 700 nm.
Power: 3.5 – 5.1 j/cm²

Besides the wavelengths, energy flow j/cm² there are many factors to more selectively target desired cellular or structural elements including pulse sequences, pulse duration, pulse delay time, filtration which is used for each treatment.

If you use the skin treatment light on the face, near the hairline, will it remove hair as well?

We don't recommend to use skin rejuvenation mode on or near the hairline, this will, cause removal of hair in the area you shot.

Does the Skin rejuvenation mode remove brown spots?

SR mode for FAUSTINA IPL helps treat brown spots by selectively heating up the pigment, Then, the heated damaged area will be lifted to the surface of the skin where it is removed by the skin natural exfoliation process. The brown spots will get darker initially over the next 24 hours, then slowly fade away over the next weeks.

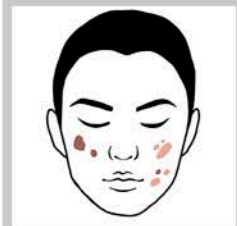
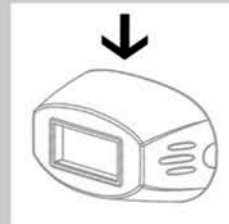

For how long should you stop using topical skin treatments (e.g. Retin A, Vitamin B, or AHA) prior to using the lased for skin rejuvenation?

Our FAUSTINA IPL is completely safe if used according to our manual. However, do not take the following medicines if you are going to proceed with an IPL treatment, as side effects may occur: **Accutane, Roaccutane, Retin A, Vitamin B, or AHA within the past 6 months.**

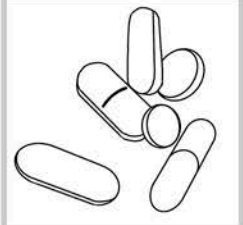

Should I use a conductive gel?

No. No need for conductive gel. You will need to make sure your skin is clean and free from any water, creams, and oils prior to using FAUSTINA IPL. After each and every treatment apply a soothing cream to let the skin cool down and to help avoid any skin irritation.



FAQs

Frequently asked questions after using the FAUSTINA IPL

What should I expect after my IPL treatment and what is the post-treatment care?

Your skin may be slightly pink or red right after your treatment, and you may experience mild swelling that should subside in a few days.

For the next 24 hours, we advise:

- No hot baths
- No swimming or sunbathing
- No tight clothing
- No application of perfumed products including deodorant, antiperspirant, self-tanner or makeup on the treated area
- No scrubbing or rubbing of the treated area (this can cause a bacterial infection)

Avoid rough sports for 24-48 hours. Hydrate your body by drinking plenty of water.

What about any skin responses?

These are often temporary and will subside within 24 hours after treatment. You can apply aftercare product after treatment to soothe your skin.



Can I use creams or ointments on my skin?

For facial treatment, you will need to make sure your face is clean and free from any water, creams, and oils prior to using IPL. After each and every treatment apply a soothing cream to let the skin cool down and to help avoid any skin irritation.



Can I proceed with other treatments, such as epilation, waxing or tweezing?

No — you should avoid these. Leave the hairs in the follicles for at least 3 days after your treatment. This will help reduce any chances of an opportunistic infection in the damaged follicles. The hair will drop out naturally over the following days and weeks. But note that hair re-growth occurs at different rates in different areas of the body.



What should I keep in mind after using an IPL?

Clean your device thoroughly and carefully following the instructions contained in your user manual.

For skin rejuvenation, its once a week for 8 weeks, and after how to use it?

It is likely that no further treatments will be needed for several years, especially if you avoiding sunbathing and if you take care of your skin by using sunscreen. Treatment results can last up to three-five years using FAUSTINA IPL, with an option to apply further treatments if you'd like.

Can I treat areas with the skin rejuvenation lamp and treat the same areas for hair removal lamp on the same day - one treatment after the other?

We don't recommend treating the same area with a skin rejuvenation lamp and hair removal lamp on the same day. You should leave two or three days between the two treatments.

Can I shave between treatmeants?

Yes, Some hair will grow in between the treatments, and it's perfectly okay to shave. However, for best results, we recommend that you don't do any form of waxing, plucking, bleaching, and electrolysis treatments. Shaving is your new favorite hair removal method between the treatments; anything else pulls hair from the follicle and hinders the IPL process, which you don't want. If hair grows back between treatments, simply shorten the treatment interval, but do not treat more often than once every 2 weeks, as this will only increase the risk of skin irritation.

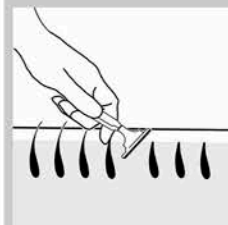

How soon can results be seen with IPL hair removal?

It all depends on the area you are treating, hormonal growth, lifestyle and medication. Leg treatments work great, and you'll see much faster reduction within six to nine treatments – Within a year to a year and a half, you'll see very good reduction on other areas. Faces do take a lot longer to treat. The reason for this is the fact that the human face is very hormonal – in one square centimetre, there are nearly five hundred hair follicles. Some of them are inactive. A new hair follicle will become active and you'll start seeing that hair growth coming back again.

Repeat the treatment every 4 to 6 weeks, this will keep your hair root inactive and prevent hair from growing back. When you continue to use IPL, you will see permanent results from the third month of treatment. This does NOT mean you will be hair free after three months — Only that you will start noticing that a lot of your body hair is not growing back. You can shave between IPL sessions, avoid plucking and waxing right after your treatments. Shaving is your new favourite hair removal method — Anything else will pull hair from their follicles and hinder the IPL process, which you don't want.

If hair grows back between treatments, simply shorten the treatment interval, but do not treat more often than once every 2 weeks, as this will only increase the risk of skin irritation.

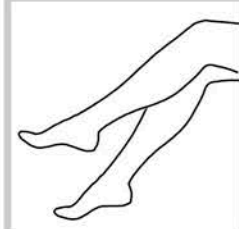

How does FAUSTINA IPL stimulate collagen production?

FAUSTINA IPL with Skin Rejuvenation lamp uses a selective range of wavelengths. The pulsed light passes through the epidermis and penetrates deeper into the skin, where the light energy causes damage to the pigment. This causes the skin's natural defenses to come to the rescue. The body instinctively works to remove the damaged melanin and stimulates fibroblasts to produce new collagen and tightening of elastin fibers, helping skin become firmer, thicker and more youthful-looking.

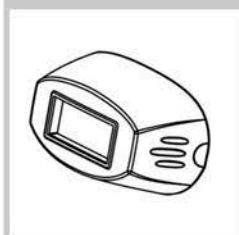

Replacing the adapter

How to replace the UK adapter to the US adapter

- 1 Pull down the semi-circle button with your thumb.**
This will release the UK adapter's head.

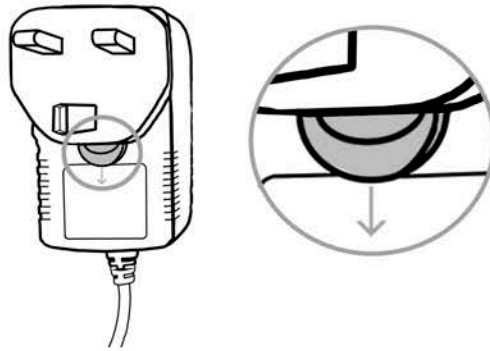

- 2 To insert the US adapter simply place it on the power connection area as shown in the picture.**

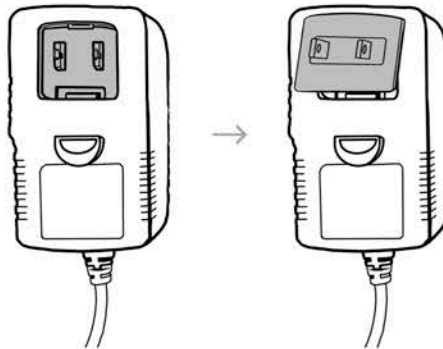

- 3 Press the adapter's head down on the AC adapter.**
When well attached you will be able to hear a click.

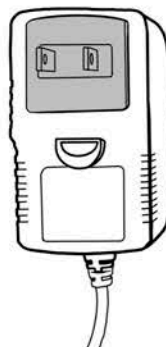

Warranty

In case anything happens...

Warranty period

- Main unit: The warranty of the main unit is 1 year from the date of purchase.
- Lamp(s): Lamp faults with over 30% of shots remaining caused by non-artificial reasons will be maintained by the manufacturer.

Warranty scope

If the system is within its warranty period, the manufacturer will replace your product with a new one after checking for non-artificial reasons. Other faults that result from abnormal use and forced maneuvers are not covered.

Warranty limits

When applying for free maintenance for the product that is within its warranty period, customers should show valid proof of purchase (such as an invoice, warranty card, any kind of receipt or bank statement, etc).

Free maintenance is not provided for products which have been damaged due to improper use or tampering.

We will not cover any of the following

- Faults and general damage caused by fires, earthquakes, third party behaviour, fault or misuse by users. Usage under any other abnormal conditions and unpredictable events.
- Any extended damage caused by the usage of your products (such as business discrepancies, loss of benefits, interruption of business including the loss of results from improper usage of system, and the resulting cost from replacement of equipment, device or service, or claim required by users).
- Damage resulted from improper use which is outside the content of instructions listed in this manual.

This includes:

Uncontrollable situations, required service of parts for solving problems that result from the usage of accessories, fittings or substitutes that are not sold by the manufacturer or our company, and the required service for solving problems that result from unacceptable or illegal disassembly and re-assembly of the instrument without proper instructions.

- Faults or damage that results from an environment that is not suitable for the product.
- Improper storage by users (such as damage caused by critters and liquid infiltration).

Service Information

Thank you for buying from us

Dear customer,

Thank you for purchasing our product! In order to provide you with the highest quality service, please refer to the contact information below if you're facing any problems or issues with your newly purchased FAUSTINA® Multifunctional IPL beauty device.

Email: support@labotest.co.uk

Company website: www.labotest.co.uk

Warranty Card

Fill in the details to make a claim

Full Name:

Product Name:

Model:

Purchase Date:

Check Out Standard:

GB4706.1-2005

Please attach proof of purchase.

This product complies with standard quality requirements after testing, and is approved for release.

**Make the world a little more
beautiful with IPL technology.**

LAB  TEST
HOME BEAUTY DEVICES & LAB EQUIPMENT

Suite 503,
Crown House Business Centre
North Circular Road,
London, NW10 7PN,
United Kingdom

www.labotest.co.uk